

# LCF02-3AO2DO RS485 Modbus

Fancoil controller (Flush mounting)

## Datasheet

Subject to technical alteration  
Issue date: 19.04.2018 • A005



## Application

The fancoil room controller has been designed for individual control of temperature in commercial, industrial and residential buildings. It is tailored for two-pipe fan coils with two-wire electric valves and has 3 analogue outputs 0..10 V (EC fan, heating valve and cooling valve). A 6-way valve can also be used. In addition, an electrical heating coil can also be connected. With its flush mounted modern design the device combines digital technology with a large LCD display and additional buttons, which enables the single room controller to be used intuitively.

## Security Advice – Caution



The installation and assembly of electrical equipment should only be performed by authorized personnel.

The product should only be used for the intended application. Unauthorised modifications are prohibited! The product must not be used in relation with any equipment that in case of a failure may threaten, directly or indirectly, human health or life or result in danger to human beings, animals or assets. Ensure all power is disconnected before installing. Do not connect to live/operating equipment.



**CAUTION! Risk of electric shock due to live components within the enclosure, especially devices with mains voltage supply (usually between 90..265 V).**

Please comply with

- Local laws, health & safety regulations, technical standards and regulations
- Condition of the device at the time of installation, to ensure safe installation
- This data sheet and installation manual

## Notes on Disposal



As a component of a large-scale fixed installation, Thermokon products are intended to be used permanently as part of a building or a structure at a pre-defined and dedicated location, hence the Waste Electrical and Electronic Act (WEEE) is not applicable. However, most of the products may contain valuable materials that should be recycled and not disposed of as domestic waste. Please note the relevant regulations for local disposal.

## Remarks to Room Sensors

### Location and Accuracy of Room Sensors

The room sensor should be mounted in a suitable location for measuring accurate room temperature. The accuracy of the temperature measurement also depends directly on the temperature dynamics of the wall. It is important, that the back plate is completely flush to the wall so that there is sufficient circulation of air through the vents in the cover, otherwise, deviations in temperature measurement will occur due to uncontrolled air circulation. The temperature sensor should not be covered by furniture or other objects. Mounting next to doors (due to draught) or windows (due to colder outside wall) should be avoided.

### Surface and Flush Mounting

The measuring result is influenced by the thermal characteristics of the wall. A solid concrete wall responds to thermal fluctuations within a room in a much slower than a light-weight structure wall. Room temperature sensors installed in flush-mounted boxes have a longer response time to thermal variations. In extreme cases they detect the radiant heat of the wall even if the air temperature in the room is lower for example. The quicker the dynamics of the wall (temperature acceptance of the wall) or the longer the selected inquiry interval of the temperature sensor is the smaller the deviations limited in time are.

## Technical Data

<b>Measuring values</b>	temperature		
<b>Output voltage</b>	<b>terminal 2   3</b> 2x 0..10 V for heating and cooling	<b>terminal 4</b> 1x 0..10 V for fan	
<b>Output switch contact</b>	<b>terminal 6   7</b> 2x normally open contact, 250 V load max. 3 A, electrical heater 3-stage		
<b>Network technology</b>	RS485 Modbus, RTU, half-duplex, baud rate 4.800, 9.600, 19.200 or 38.400, parity: non (2 stopbits), even or odd (1 stopbit)		
<b>Power supply</b>	24 V = ( $\pm 10\%$ )   24 V ~ ( $\pm 20\%$ ) SELV		
<b>Power consumption</b>	3 W (24 V =)		
<b>Measuring range temp.</b>	+1..+50 °C		
<b>Accuracy temperature</b>	$\pm 1$ K (typ. at 21 °C)		
<b>Inputs</b>	<b>terminal 10</b> input for external sensor NTC10K	<b>terminal 11 – ESI   DP</b> input digital for floating contact, window contact, dew point sensor	<b>terminal 12 - OCC</b> input digital for floating contact, occupancy sensor, key card switch
<b>Control functions</b>	set point adjustment +1..+50 °C, (default +16..+30 °C)		
<b>Display</b>	LCD 64x41 mm, white background lighting		
<b>Enclosure</b>	ABS, pure white		
<b>Protection</b>	IP20 according to EN 60529		
<b>Cable entry</b>	rear entry		
<b>Connection electrical</b>	terminal block max. 1,5 mm <sup>2</sup>		
<b>Ambient condition</b>	-10..+50 °C, max. 95% rH non-condensing		
<b>Weight</b>	160 g		
<b>Mounting</b>	flush mounted with standard EU box ( $\varnothing=55$ mm)		

### Connection Plan

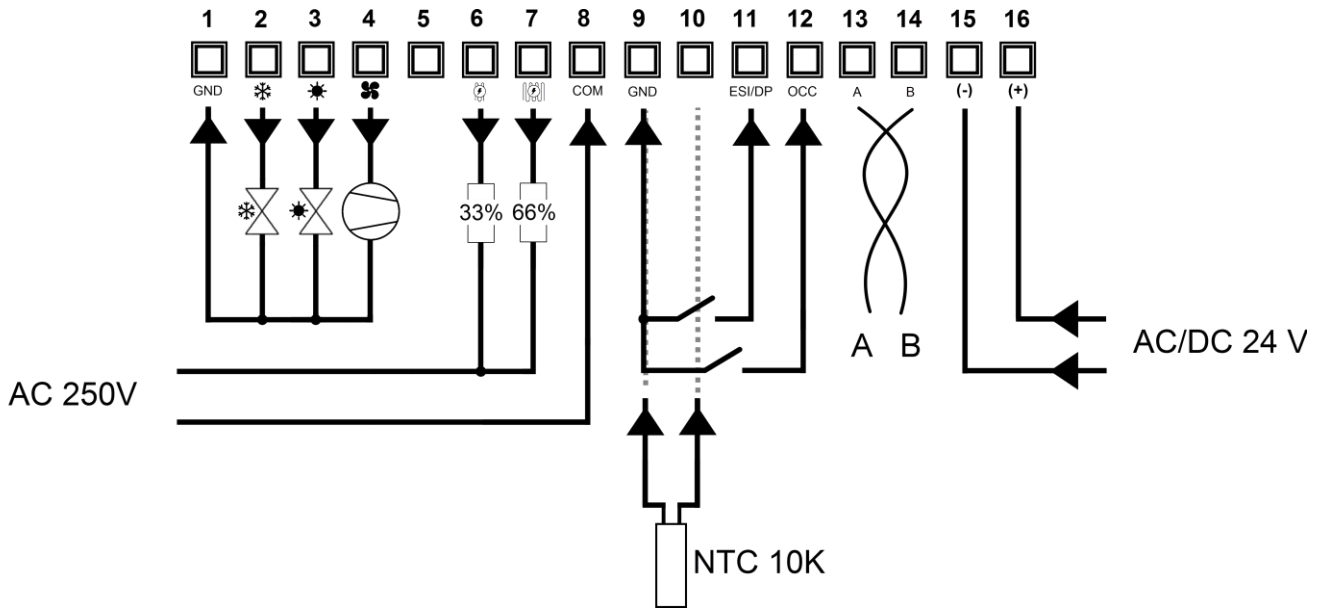

### Controller output signal

		4-pipe (default)	2-pipe	6WV – 6-way valve
Terminal 2		Cooling	Heating & Cooling	Heating & Cooling
Terminal 3		Heating		

### Display Panel

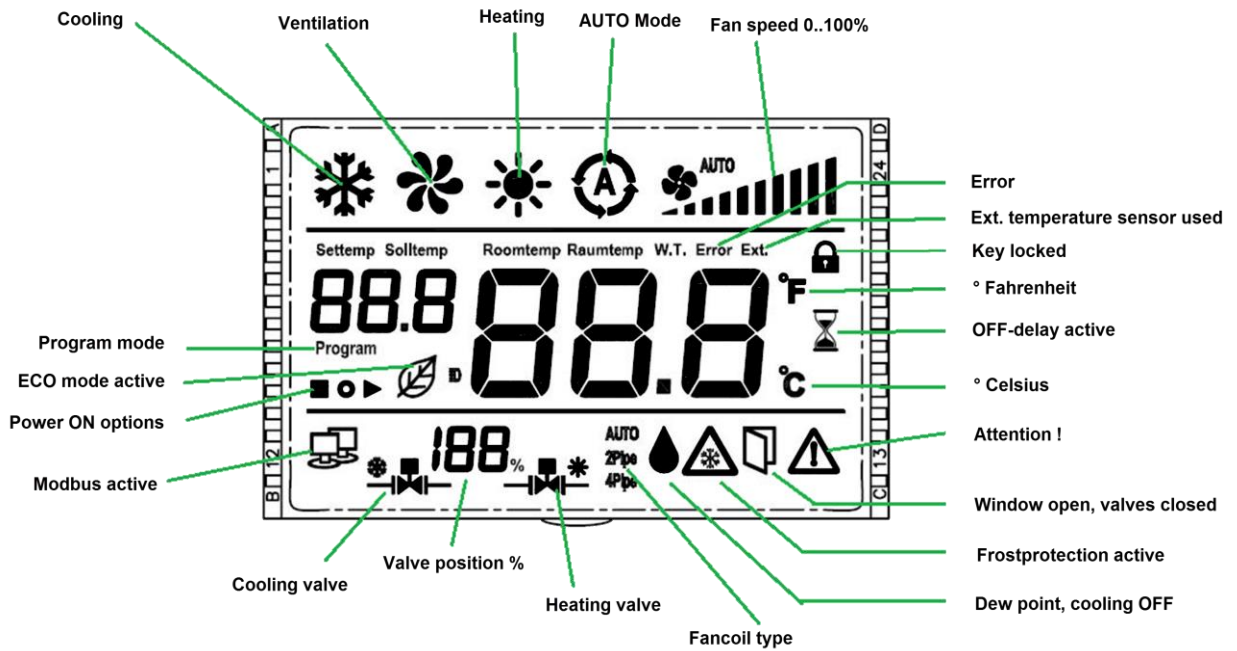

## Function Description

### Communication Modbus

<b>Communication-section</b>	1..247
<b>Factory default:</b>	1
<b>Address 0:</b>	broadcast address
<b>Communication-Interface:</b>	RS485
<b>Communication-Protocol:</b>	Modbus-RTU
<b>Baud Rate:</b>	4800 bps / 9600 bps / 19200 bps / 38400 bps (optional)
<b>Factory default:</b>	9600 bps
<b>Parity:</b>	no parity / odd parity / straight parity (optional)
<b>Factory default:</b>	no parity
<b>Data:</b>	8 bit
<b>Stop:</b>	2 bit

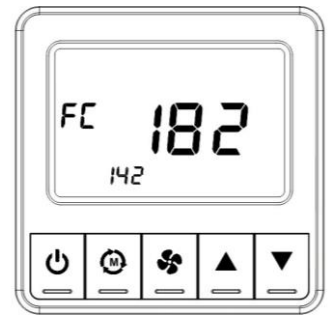

During device start-up the version and type number are displayed on the start screen for a short time.

While the fan coil thermostat is communicating via the bus, the communication symbol  starts flashing. If the device does not communicate via the bus, the symbol will be disappear after 10 seconds.

### Parameter table

To enter the parameter table, press the “Mode Key for more than 5s. Once the Display comes on, it will prompt for the password (default 987). The password can be entered digit by digit. Each digit can be increased / decreased using the “▲” or “▼” keys. With the “Mode Key” the next digit will be selected.

Each parameter can be increased / decreased using the “▲” or “▼” keys. With the “Mode Key” the display will move on to the next parameter. Once the end of the table is reached the parameter setting will be exited to normal operation.

No.	Name of parameter	Parameter definition	Factory default
1	<b>Modbus address</b>	ID.1- ID.247	1
2	<b>Baud rate</b>	1:4800bps,2:9600,3:19200,4:38400	2
3	<b>Parity</b>	0:none, 1:odd 2:even	0
4	<b>Stop Bits</b>	1 = 1 Stopbit; 2, = 2 Stopbits	2
5	<b>Temperature Offset</b> Internal Sensor	-5,0 K..+5,0 K	0
6	<b>Temperature Offset</b> External Sensor	-5,0 K..+5,0 K	0
7	<b>Piping system</b>	0 = 2-pipe, 1 = 4-pipe	1
8	<b>Reset to Factory Settings</b>	Setting Parameter to 1 and press the Mode Key resets the device to factory settings. Device stays in Parameter menu for Modbus configuration	0

The Fancoil controller is designed for fan coil units with 2- or 4-pipe systems for heating and cooling. The selection of the fan coil system has to be done via the parameter No. 7.

### PI-controller 0..10 V

The manipulated variable is output as a proportional control signal. The type of valve used is set via the configuration registers.

### 6WV

With register address 304, a 6-way valve can also be selected as valve type. You can choose from 2..10 V / 2..10 V INV (Belimo), 0..10 V DN15 / DN15 INV, DN20 / DN20 INV (Sauter).

### Electric heater

The relay contacts 6 and 7 can be used to connect a heating coil with up to 3 stages. With the registers 301 to 303, the switching thresholds of the respective stages can be set.

### Operating mode

Press the "Mode Key"  , to adjust the mode cyclically (Cooling > Ventilating > Auto mode > Heating ...).

In 2-pipe configuration not available modes (depending on the change-over sensor's signal) will be skipped. In this case the user can select the available modes only.

### Standby / ECO / ON

The Power-Button switches the device from Stand-by to ON. In Standby the display is off, but the control loop is actively monitoring the temperature and will activate the heating output if the room temperature drops below the frost protection threshold.

In case the external sensor is configured as a temperature limiter, the heating valve will be closed in case the threshold value will be exceeded. Besides the frost protection the device shall monitor a high limit as well in case the external sensor input is configured as a temperature limiter. This is the case for floor heating systems, where the external sensor is embedded in the floor. In case the floor temperature will exceed a certain threshold the heating valve shall be closed to avoid damaging the floor or the pipes embedded in the floor.

Pressing the button once switches the display on and the device to ECO mode. In ECO mode it controls the room temperature to the setpoint predefined by register 275 and 276 (0x0113, 0x0114). The display will show the average of both ECO Setpoint Temperatures (25+18 /2=21,5) and the leaf symbol to indicate the ECO mode. In ECO mode the setpoint is fixed and the device does not react to any button pressed by the user besides pressing the Stand-by /ECO/ON button a 2nd time. Then it will switch from ECO to comfort mode. To indicate that the Fancoil thermostat is in ECO mode it will show the leaf and the word ECO in the display.

In case an occupancy sensor is connected to one of the inputs the mode will change from ECO to Comfort as soon as the input becomes active and the previously used Setpoint will be restored and the leaf symbol will not be showing any more.

### Temperature sensor input – temperature limiter and external sensor

The temperature sensor input (address 0x0152) can be used as change over sensor (addresses 0x012B and 0x012C) or as external temperature sensor.

Furthermore, it can also be used to limit the heating temperature (address 0x010A) and cooling temperature (address 0x010B). This is the case for floor heating systems, where the external sensor is embedded in the floor. In case the floor temperature will exceed a certain threshold the heating valve shall be closed to avoid damaging the floor or the pipes embedded in the floor.

### Fan control

If the fan is configured to be 1-stage or 2-stage the selection will be adapted accordingly. In „ventilating mode“, the valves will be closed. If the fan speed  is set to Auto the steps are switched depending on the temperature difference between the setpoint value and the current temperature value.

In auto mode heating or cooling, the fan level is calculated from the output of the PI loop (control variable).

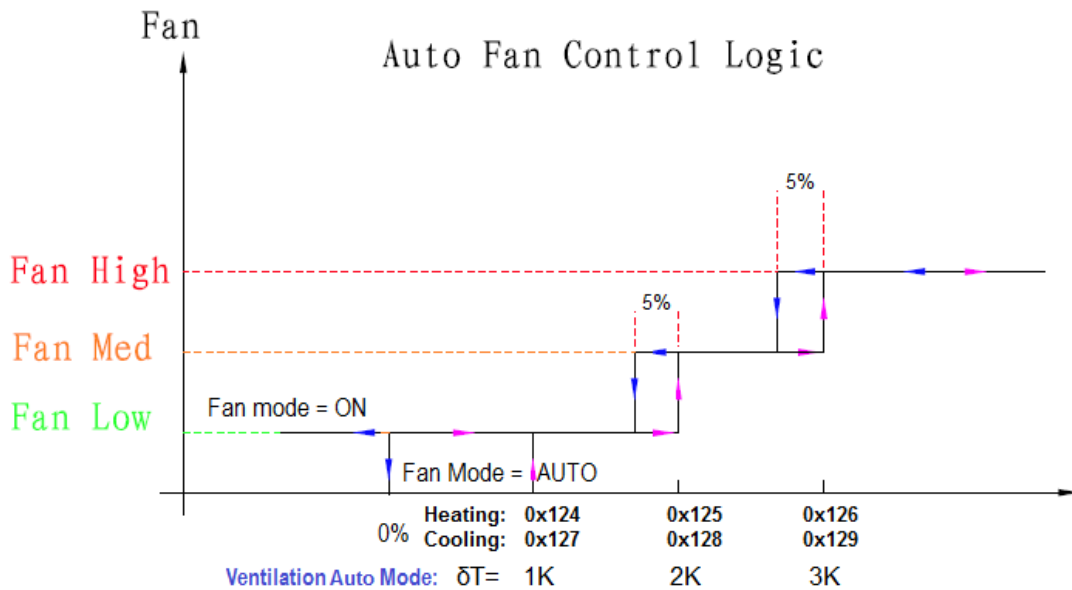

The analog 0..10 V output for the EC fan in automatic mode outputs the voltage value according to the control value of the controller. For manual switching, the following voltage values apply to the EC output:

Fan stage	Voltage	Parameter
OFF	0V	
(Speed level 1) LOW	3,5 V	Reg. 0x128, default = 35
(Speed level 2) Medium	7 V	Reg. 0x129, default = 70
(Speed level 3) High	10 V	

**°F/°C selective**

Temp display range is 32 °F..99 °F, respectively 0 °C..50 °C (factory default is °C).

**Temperature offset correction** (Register address 0x0106)

The internal sensor will be affected by the Thermostat’s self-heating. As a consequence it would display a higher room temperature than the average of indoor temperature (real value). Item 5 & 6 of the parameter table does contain the correction of temperature offset (resolution 0,1 °C).



**Set the Temperature set point range** (Register address 0x0110 – 0x0112)



Press “▲” or “▼” key to adjust the temperature set point range. Factory default (°C) is 16 °C..30 °C, When °F has been selected Temp range is 60 °F..86 °F.

**Key lock selection** (Register address 0x010D)

If a key is pressed that is locked, the lock symbol  will appear for 2s and blink 2x but no further action is taken.

**Power failure – Restart selection** (Register address 0x010C)

On the LCD, there are three symbols    that define how the thermostat will restart after a power failure:

-  Keep thermostat switched OFF
-  Switch thermostat to last state before power failure (Record and Memorize)
-  Turn the thermostat ON

**Memo while the power failure**



The status will be kept in EEPROM, while the power failure, so no data will be lost.

**Occupancy (OCC)**

If the input is configured for an Occupancy sensor. If the sensor indicates “UnOccupied” the current setpoint will be replaced by the Eco Mode Setpoint Temp. The display will show the leaf symbol and the lettering ECO to indicate the ECO mode. Once the room occupancy is detected again the previously used Setpoint will be restored and the leaf symbol will not be showing any more.

**Window contact (ESI)**

If the input is configured as window contact, the “Window open” Symbol will be displayed the thermostat will check every 3 seconds the input whether active. The cooling valve will be closed as long as the input will be active. The rest of the thermostat will work as usual, the user may change the setpoint or the fan stage, but the valve outputs will remain in valve closed position. If

configured the “Window open”  or the Dew Point symbol  will be flashing. When the input will not be active, the thermostat’s outputs return to normal operation and operates the outputs normally.

**Sensor failure alarm**

In case the room NTC temp sensor is open or short, thermostat switches fan to medium and the valve to 50% (5V output, 50%). The display will show (blinking) error code: “E1” Thermostat will allow to control fan manually as well as the valve output using the “▲” or “▼” keys. Every operation of the “▲” or “▼” keys will decrement / increment the output voltage by 1V = 10% AND the PWM by 10%. The percentage is shown in the display.

## Input Register

Address	Access	Description	Resolution / Unit	
0	0x0000	Read-only <b>Thermokon Model identification</b> 0xFF01 = FC182 LCF-3AO2DO		
1	0x0001	Read-only <b>Firmware-Version</b> e.g. 0x1A20 = 1.10.2.0		
2	0x0002	Read-only <b>Back-Box type</b> 32 = 3AO2DO		
3	0x0003	Read-only <b>Value of the integrated temperature sensor °C</b> 0...500 -> 0...50,0°C	0,1	°C
4	0x0004	Read-only <b>fan status</b> 0x00 = Manual OFF 0x01 = Manual low 0x02 = Manual medium 0x04 = Manual high 0x08 = Auto OFF 0x09 = Auto low 0x0A = Auto medium 0x0C = Auto high		
5	0x0005	Read-only <b>VA1 status</b> 0-100 0 = 0 (Off) ...100% (On)		
6	0x0006	Read-only <b>VA2 status</b> 0-100 0 = 0 (Off) ...100% (On)		
7	0x0007	Read-only <b>electrical heating status</b> 0-1000 = 0 ...100%	0,1	
8	0x0008	Read-only <b>external temperature sensor °C</b> 200...+1000 -> -20,0...+100,0°C	0,1	°C
9	0x0009	Read-only <b>failure status</b> 0x00=no failure 0x01= control loop temperature sensor alarm 0x02=external temperature sensor high limit Alarm 0x04=external temperature sensor low limit Alarm 0x08= change over sensor missing alarm		
10	0x000A	Read-only <b>External input 1</b> 0 = Contact Open, 1= contact closed (for window contact, dew point sensor)		
11	0x000B	Read-only <b>External input 2</b> 0 = Contact Open, 1= contact closed (for OCC-sensor, keycard Switch)		

## Holding Register

General settings					
Address	Access	Description	Resolution / Unit		Default
256	0x0100	Read-write <b>Customer set Device location identification</b> 1..247	1.0		1
257	0x0101	Read-write <b>LCD Temperature Unit</b> 0=°C 1=°F			0
258	0x0102	Read-write <b>Beeper Intensity</b> 0=Off 1=Max			1
259	0x0103	Read-write <b>Backlight intensity operated</b> 0..100	1.0	%	80
260	0x0104	Read-write <b>Backlight intensity non operated</b> 0..100	1.0	%	20
261	0x0105	Read-write <b>Backlight operating delay setting</b> 0 = always ON 1...255 = 1...255 seconds ON	1.0	s	15
262	0x0106	Read-write <b>Internal Sensor Temperature Offset</b> (added to measured value) -50...50 -> -5,0...5,0°C	0.1	°C	0
263	0x0107	Read-write <b>external Sensor Temperature Offset</b> (added to measured value) -50...50 -> -5,0...5,0°C	0.1	°C	0
264	0x0108	Read-write <b>Display language</b> 0= German 1 = English			0
265	0x0109	Read-write <b>Individual passwords setting</b> 001-999, default=987, 000 = no password			987
266	0x010A	Read-write <b>External temperature (limiter) sensor high limit (338=3, for limiter)</b> -200...+1000 -> -20,0...+100,0°C	0.1	°C	40
267	0x010B	Read-write <b>External temperature (limiter) sensor low limit (338=3, for limiter)</b> -200...+1000 -> -20,0...+100,0°C	0.1	°C	0
268	0x010C	Read-write <b>Power failure</b> 0=keep off after power-on-reset			1

			1=return to last state after power failure 2=switch on after power-on-reset	
269	0x010D	Read-write	<b>Key-lock</b> 0x00=unlocked 0x01=lock on/off 0x02=lock mode 0x04=lock clock (FC 261 only) 0x08=lock fan speed 0x10=lock temp setting 0x1F=lock all keystrokes Once a locked key is pressed the LOCK symbol shall be displayed and blink twice.	0
270	0x010E	Read-write	<b>Display Settings</b> 0b00000001= show Setpoint (if no setpoint is shown the setpoint keys are locked = 0x010D = 0x10=lock temp setting) 0b00000010= show Room temperature 0b00000100 = show valve symbol 0b00001000 = show PI-Loop percentage 0bxxx10000 = show Room temperature from Register 0x207 (if only room temp or setpoint is shown, then in big numbers)	15

### Set point settings

Address	Access	Description	Resolution / Unit		Default
271	0x010F	Read-write <b>Default Setpoint after Power On Reset</b> 0...500 -> 0...50,0°C	0.1	°C	210
272	0x0110	Read-write <b>Setpoint temperature lower limit</b> 0...500 -> 0...50,0°C	0.1	°C	160
273	0x0111	Read-write <b>Setpoint temperature upper limit</b> 0...500 -> 0...50,0°C	0.1	°C	300
274	0x0112	Read-write <b>Setpoint increment/decrement value</b> 1...100 -> 0,1...10,0°C	0.1	°C	5
275	0x0113	Read-write <b>ECO mode temperature setpoint cooling</b> 250...450 = 25,0...45,0°C	0.1	°C	300
276	0x0114	Read-write <b>ECO mode temperature setpoint heating</b> 120...240 = 12,0...24,0°C	0.1	°C	190

### PI controller

Address	Access	Description	Resolution / Unit		Default
277	0x0115	Read-only <b>Controller mode</b> 0b0000 0000=FC182 off (Frost protection active), Comfort Mode 0b0000 0001= controller auto mode (heating&cooling), Comfort Mode 0b0000 0010= controller heating mode only, Comfort Mode 0b0000 0011= controller cooling mode only, Comfort Mode 0b0000 0100= ventilating (PI loop controls fan stages only, valves closed)  0b0001 0000= FC182 off (Frost protection active), ECO Mode 0b0001 0001= controller auto mode (heating&cooling), ECO Mode 0b0001 0010= controller heating mode only, ECO Mode 0b0001 0011= controller cooling mode only, ECO Mode 0b0001 0100= ventilating (PI loop controls fan stages only, valves closed)			1
278	0x0116	Read-write <b>Fan coil type</b> 0b00000000= 2-pipe : cooling&heating with Change-Over 0b00000001= 4-pipe : cooling&heating 0b0000001X=electric-heater			1
279	0x0117	Read-write <b>Fan stages and operation modes</b> 0b00000000 = none, (fan key is locked the fan symbol will be faded on the LCD) 0bxxxx0001 = single stage; 0bxxxx0010 = 2 stages 0bxxxx0011 = 3 stages 0bxxxx1000 = EC Fan 0b0001xxxx = fan works not in heating mode 0b0010xxxx = fan works not in cooling/ventilation mode			3



(0b0011xxxx = fan works not in heating & cooling mode)						
280	0x0118	Read-write	<b>Start fan at highest stage for _ seconds</b> 0...60 -> fan start at highest fan stage for 0...60s seconds	1.0	s	0
281	0x0119	Read-write	<b>Fan OFF-Delay</b> 0= fan never stops 1..255 = Fan stops 1...255 minutes after valves closing	1.0	min	15
282	0x011A	Read-write	<b>PWM Cycle time</b> 1...255 Minutes			15
283	0x011B	Read-write	<b>Deadband</b> 1...100 -> 0,1...10,0K	0.1	K	10
284	0x011C	Read-write	<b>Heating Proportional Band Xp_heat</b> 1...100 -> 0,1...10,0°C	0.1	°C	20
285	0x011D	Read-write	<b>Heating Integration Time Tn_heat</b> 0...255 = 0...255 Minutes	1.0	min	30
286	0x011E	Read-write	<b>Cooling Proportional Band Xp_cool</b> 1...100 -> 0,1...10,0°C	0.1	°C	20
287	0x011F	Read-write	<b>Cooling Integration Time Tn_cool</b> 0...255 = 0...255 Minutes	1.0	min	30
288	0x0120	Read-write	<b>Minimal limit of the control variable heat</b> 0..100	1.0	%	0
289	0x0121	Read-write	<b>Maximal limit of the control variable heat</b> 0..100	1.0	%	100
290	0x0122	Read-write	<b>Minimal limit of the control variable cool</b> 0..100	1.0	%	0
291	0x0123	Read-write	<b>Maximal limit of the control variable cool</b> 0..100	1.0	%	100
296	0x0128	Read-write	<b>Fan stage 1 (LOW) Voltage value</b> 0..100 = 0..10 V	0.1	%	35
297	0x0129	Read-write	<b>Fan stage 2 (Medium) Voltage value</b> 0..100 = 0..10 V	0.1	%	70
298	0x012A	Read-write	<b>Frost protection temperature threshold</b> 50...150 -> 5,0...15,0°C	0.1	°C	70
299	0x012B	Read-write	<b>Change-Over Temperature Threshold for Heating</b> 0...500 -> 0...50,0°C	0.1	°C	300
300	0x012C	Read-write	<b>Change-Over Temperature Threshold for Cooling</b> 0...500 -> 0...50,0°C In case temperature is in between both thresholds the last state will be maintained	0.1	°C	190
301	0x012D	Read-write	<b>Electrical Heater Stage 1 Threshold control variable</b> 0..100%	1.0	%	65
302	0x012E	Read-write	<b>Electrical Heater Stage 2 Threshold control variable</b> 0..100%	1.0	%	80
303	0x012F	Read-write	<b>Electrical Heater Stage 3 Threshold control variable</b> 0..100%	1.0	%	90
304	0x0130	Read-write	<b>Valve type selection</b> 4= proportional (0V = 0% ..10V = 100%) 5=invers proportional (0V = 100% ..10V = 0%) 6=proportional Belimo 6 way 7=proportional Sauter 6 way with Ø15mm 8=proportional Sauter 6 way with Ø20mm 9=proportional Belimo 6 way, counter direction 10=proportional Sauter 6 way with Ø15mm, counter direction 11=proportional Sauter 6 way with Ø20mm, counter direction 12=no valve			4

## Inputs

Address	Access	Description	Resolution / Unit	Default
336	0x0150	Read-write		0
		<b>Configuration external input 1</b> 0 = No function 1 = Occupancy sensor (Open = Occupied) 2 = Occupancy sensor (Closed =Occupied) 3 = Window contact (Open = Window Open) 4 = Window contact (Closed = Window Open) 5 = Disable heating (Open = Heating disabled) 6 = Disable heating (Closed = Heating Disabled) 7 = Disable cooling (Open = Disable Cooling) 8 = Disable cooling (Closed = Disable Cooling) 9 = Dew Point Sensor (Open = Dewpoint crossed, disable cooling) 10 = Dew Point Sensor (Closed = Dewpoint crossed, disable cooling)		
337	0x0151	Read-write		0
		<b>Configuration external input 2</b> 0 = No function 1 = Occupancy sensor (Open = Occupied) 2= Occupancy sensor (Closed =Occupied) 3 = Window contact (Open = Window Open) 4 = Window contact (Closed = Window Open) 5 = Disable heating (Open = Heating disabled)		

			6 = Disable heating (Closed = Heating Disabled) 7 = Disable cooling (Open = Disable Cooling) 8 = Disable cooling (Closed = Disable Cooling) 9 = Dew Point Sensor (Open = Dewpoint crossed, disable cooling) 10 = Dew Point Sensor (Closed = Dewpoint crossed, disable cooling)			
338	0x0152	Read-write	<b>Configuration Sensor Input</b> 0= none 1 = Change Over Temp sensor (NTC10K) 2 = Ext. Temp sensor (NTC10K) 3 = Temperature Limiter			0
339	0x0153	Read-write	<b>ESI (Energy Savings Input) - ON delay</b> ON delay for ESI. Delays Energy stop by n seconds	1.0	s	0
340	0x0154	Read-write	<b>OCC input - OFF delay</b> 0...65535 -> 0...65535 seconds	1.0	s	1800

**Holding Register (operation to override FC from Modbus)**

Address	Access	Description	Resolution / Unit	Default
512	0x0200	Read-write <b>Active fan speed setting</b> 0 = OFF 1, 2, 3 = Stage 1, 2, 3 4 = Auto / DC-Fan		0
513	0x0201	Read-write <b>setpoint temperature</b> 0...500 -> 0...50,0°C		0
514	0x0202	Read-write <b>Controller Mode</b> b0000 0000=FC182 off (Frost protection active), Comfort Mode 0b0000 0001= controller auto mode (heating&cooling), Comfort Mode 0b0000 0010= controller heating mode only, Comfort Mode 0b0000 0011= controller cooling mode only, Comfort Mode 0b0000 0100= ventilating (PI loop controls fan stages only, valves closed)  0b0001 0000= FC182 off (Frost protection active), ECO Mode 0b0001 0001= controller auto mode (heating&cooling), ECO Mode 0b0001 0010= controller heating mode only, ECO Mode 0b0001 0011= controller cooling mode only, ECO Mode 0b0001 0100= ventilating (PI loop controls fan stages only, valves closed)		0
515	0x0203	Read-write <b>Active Symbols</b> 0x00= show none 0x01= show Leaf 0x02= show dew point 0x04= show frost protect ON 0x08= show open window 0x10= show Attention! 0x20= show hourglass, OCC input - OFF delay (0x0154) 0x40= show lock 0x80= show ECO		0
516	0x0204	Read-only <b>VA1 status</b> 0-1000 = 0 (Off) ...100% (On)	0.1 %	0
517	0x0205	Read-only <b>VA2 status</b> 0-1000 = 0 (Off) ...100% (On)	0.1 %	0

## Mounting advice/ Dimensions (mm)

For installing or maintenance, please make sure the power is disconnected. Fix the thermostat base plate to the wall through the four screw holes with distance between axes of 60 mm. Fasten base plate and front cover. Do not press the panel in order to protect LCD.

